



This is part of **Family API** which allow to create dual-os version of program runs under OS/2 and DOS

**Note:** This is legacy API call. It is recommended to use 32-bit equivalent

2021/09/17 04:47 · prokushev · [0 Comments](#)

2021/08/20 03:18 · prokushev · [0 Comments](#)

# Video Subsystem

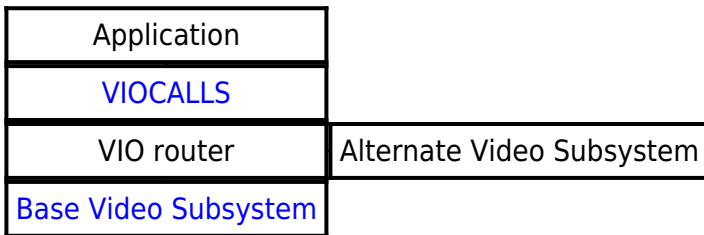

OS/2 Video subsystem placed in VIOCALLS.DLL by default (or some another place for other OSes). Called VIO function passes control to VIO router function which, depends on registered functions replacement, routes call to Base Video Subsystem (BVSCALLS.DLL) or to registered Alternate Video Subsystem.

Such route in original OS/2 1.x serie. First versions doesn't include BVH and Global Video Sybsystem hook. In OS/2 1.2 version includes them. Base Video Subsystem utilises Base Video Handlers (BVH\*.DLL). Base Vide Handler is a sort of video hardware abstraction layer. Global Video Subsystem allow to add notification hooks after VioRoute call.

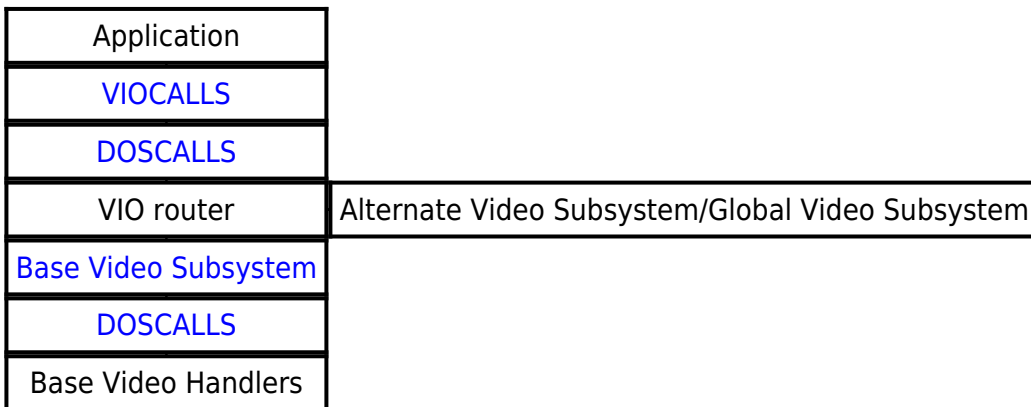

In late OS/2 versions (3.x?) actual code of Video subsystem and Base Video Subsystem was moved to DOSCALLS.DLL (see Fig). OS/2 Video Subsystem is 16-bit. Later three inepended versions of 32-to-16 bit wrapper subsystems was developed (See Fig)

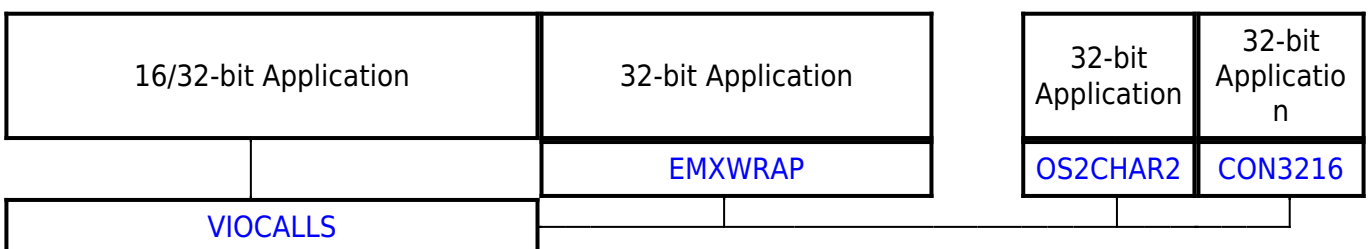

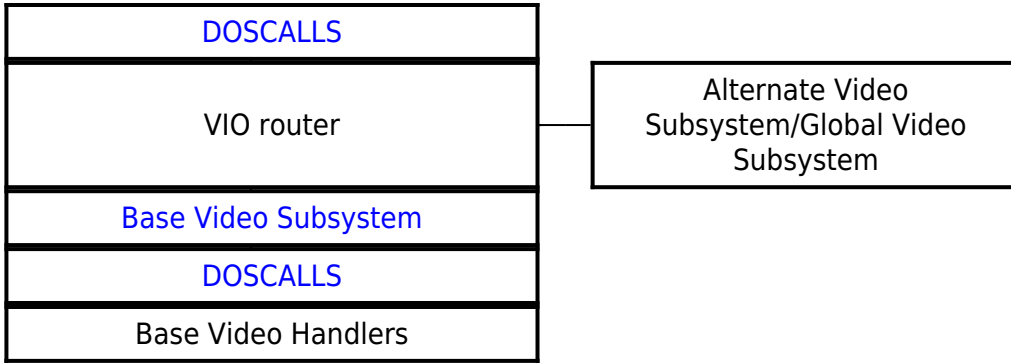

Under DOS original IBM Family API or JdeBP's Family API applications uses following call route

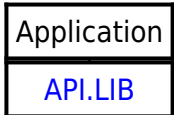

Under HX DOS Extender OS/2 Emulation Family API applications uses following route



Under DOS osFree Family API supports following route

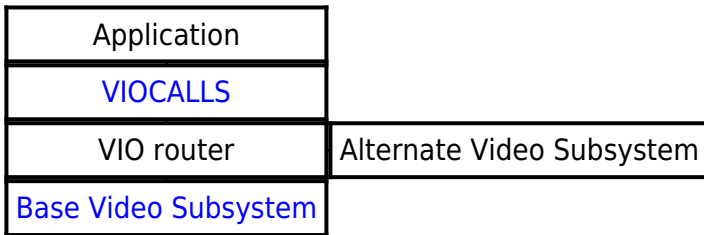

osFree attempts to combine all approaches and provide following callflow

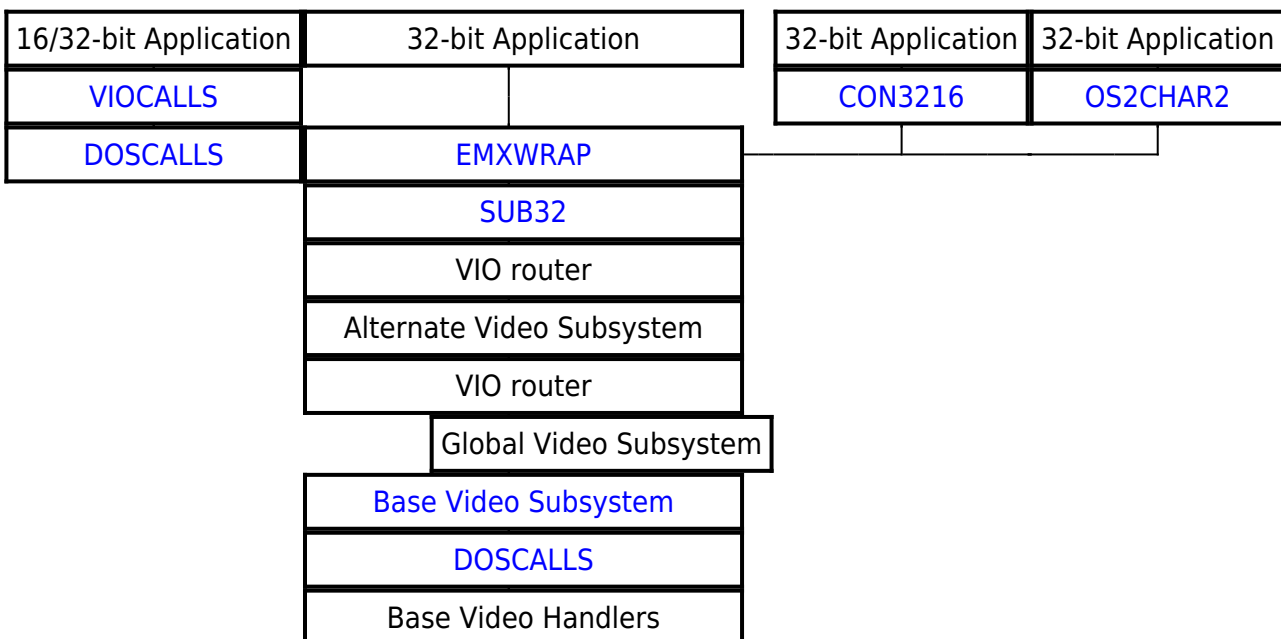

From:

<https://osfree.org/doku/> - **osFree wiki**

Permanent link:

<https://osfree.org/doku/doku.php?id=en:docs:os2:api:vio&rev=1631595433>

Last update: **2021/09/14 04:57**

